

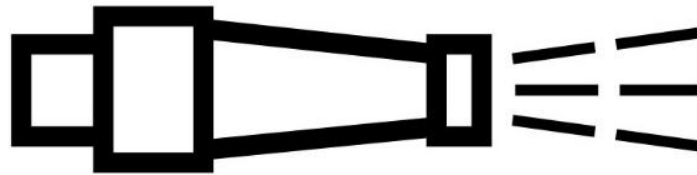

TC008:2019

Graphical Symbols for Automotive Fire Apparatus



Prepared by the FAMA Technical Committee

This guide does not endorse any manufacturer or product



Contents

1 - Scope.....	3
2 – Reference Documents.....	3
3 - Definitions	4
4 - General.....	4
5 - Color.....	6
6 - Adaptation of Symbols as Digital Display Icons.....	6
7 - Application Rules.....	7
8 – Base Symbols.....	9
9 – General	11
10 – Discharges and Intakes	26
11 - Tanks.....	32
12 - Fire Suppression Pump Functions and Features	36
13 - Hose	43
14 – Aerial Device.....	45
15 - Stabilizers	51
16 - Electrical.....	59
17 - Lighting	61
18 - Foam and CAFS.....	72
19 – Revisions	74



1 - Scope

This document presents graphical symbols for use on operator controls and other displays on fire and rescue apparatus. These symbols are appropriate for vehicles designed to meet NFPA 1901 *Standard for Automotive Fire Apparatus*, NFPA 1906 *Standard for Wildland Apparatus*, and NFPA 414 *Standard for Airport Rescue and Fire Fighting Vehicles*.

This document gives the fire and rescue community an option for labeling common controls with a graphical representation of their function. This can be either in place of, or in addition to, the traditional text description. Some symbols have been adopted from already established sources, and many of the symbols are identical or similar to those being developed for use in Europe.

2 – Reference Documents

The following publications form a part of this specification to the extent specified herein. The latest issue of SAE publications shall apply.

SAE J1362	Graphical Symbols for Operator Controls and Displays on Off-Road Self-Propelled Work Machines
ISO 7000	Graphical symbols for use on equipment—Index and synopsis
ISO 7296-2	Cranes—Graphical symbols—Part 2: Symbols for mobile cranes
ISO 80416-2	Basic principles for graphical symbols for use on equipment—Part 2: Form and use of arrows
ISO 80416-4	Basic principles for graphical symbols for use on equipment—Part 4: Guidelines for the adaptation of graphical symbols for use on screens and displays (icons)
ISO 8999	Reciprocating internal combustion engines -- Graphical symbols
CEN 15989	Fire Fighting Vehicles and Equipment – Symbols for Operator Controls and Other Displays
IEC 60417	Graphical symbols for use on equipment



- IEC 80416-1 Basic principles for graphical symbols for use on equipment—Part 1: Creation of symbol originals
- IEC 80416-3 Basic principles for graphical symbols for use on equipment—Part 3: Guidelines for the application of graphical symbols
- NFPA 1901 Standard for Automotive Fire Apparatus
- NFPA 1906 Standard for Wildland Fire Apparatus
- NFPA 414 Standard for Airport Rescue and Fire Fighting Vehicles.

3 - Definitions

Symbol A visually perceptible figure used to transmit information independent of language. It may be produced by drawing, printing, or other means.

4 - General

1. New symbol ideas should be forwarded to FAMA. The FAMA Graphical Symbols group will consider new symbols at each FAMA technical committee meeting and add new symbols as appropriate.
2. Use symbols as shown in this document. However, symbols which are shown in outline form may be filled in actual use for enhanced clarity of reproduction and improved visual perception by the operator, unless otherwise noted for individual symbols. Refer to IEC 80416-3.
3. Limitations inherent in some reproduction and display technologies may require increased line thickness or other minor modifications of symbols. Such modifications are acceptable provided the symbol is unchanged in its basic graphical elements and remains easily discernible by the operator.
4. To improve the appearance and perceptibility of a graphical symbol, or to coordinate with the design of the equipment to which the symbol is applied, it may be necessary to change the line thickness or round the corners of a symbol. The graphic designer is free to make such changes, provided that the essential perceptual characteristics of the symbol are maintained.



5. For actual use, all symbols shall be reproduced large enough to be easily discernible by the operator. See IEC 80416-1 for guidelines on the proper sizing of symbols. Symbols grouped together in a display or on a set of controls should be scaled to the same degree relative to the corner marks of the original symbol as shown in this in this document in order to maintain the correct visual relationship among the symbols. Symbols shall be used in the orientation shown in unless otherwise noted for individual symbols.
6. Most symbols are constructed using a building block approach in which various symbols and symbol elements are combined in a logical manner to produce new symbols.
7. Symbols are generally intended to replace a word or words with a graphical representation that has the same meaning for all operators, regardless of their native language. However, the use of a graphical symbol to identify a control or display does not preclude the use of words in conjunction with that control or display.
8. Symbols on controls and displays shall have good contrast to their background. Displays may use either a light symbol on a dark background or a dark symbol on a light background, depending upon which alternative provides the best visual perception. When a symbol image is reversed (for example, from black-on-white to white-on-black and vice versa), it shall be done for the entire symbol.
9. Symbols shall be located on or adjacent to the control or display that is being identified. Where more than one symbol is required for a control, the symbols shall be located in relation to the control such that movement of the control toward the symbol shall effect the function depicted by that symbol.
10. Reference numbers and the standards they come from are provided for each symbol not unique to this document. This list is not exhaustive. Certain symbols may be found in more than one standard, or in standards not referenced here.
11. Symbols are shown within the outer limits of a 24 mm square grid (32 percent of original ISO graphics grid size). Corner marks delimit the corners of the 75 mm square graphics grid from IEC 80416-1. Corner marks are not part of the symbol itself



5 - Color

1. When used to indicate operating status or condition, the following colors have meaning as follows:

Red The color red shall denote a failure, serious malfunction, or dangerous operating condition that requires immediate attention.

Yellow The color yellow or amber denotes a condition outside normal operating limits or approaching a dangerous operating condition.

Green The color green or denotes a normal operating condition.

2. Color coding should not be used to provide any unique information since 7 percent of the male population is color blind. Use colors to assist if desired but the operator should not need to rely on the colors for essential information.
3. The following color chart may be used to produce standard safety colors:

Color	Pantone	Process Color				sRGB			HTML Code
		C	M	Y	K	R	G	B	
Blue	2945C	100	52	2	12	0	84	159	00549F
Green	3415C	100	5	72	24	0	122	77	007A4D
Orange	152C	0	62	100	0	225	112	0	E17000
Red	485C	0	93	95	0	213	43	30	D52B1E
White		0	0	0	0	255	255	255	FFFFFF
Yellow	109C	0	10	100	0	254	209	0	FED100

6 - Adaptation of Symbols as Digital Display Icons

Symbols may be adapted for use as digital display icons on reconfigurable or other electronic displays. Such adaptations should follow the principles of ISO 80416-4. Special care should be taken to ensure that digital display icons preserve the visual impression of the symbol from which the icon is adapted



7 - Application Rules

1. Numbering Discharges

Number all driver side discharges beginning at the exact center of the apparatus front bumper using odd numbers going CCW around the driver side and ending before the center of the rear bumper

Number all passenger side discharges beginning just past the center of the apparatus front bumper using even numbers going CW around the passenger side and ending at the exact center of the rear bumper

2. Numbering Intakes

Number all driver side intakes beginning at the exact center of the apparatus front bumper using odd numbers going CCW around the driver side and ending before the center of the rear bumper

Number all passenger side intakes beginning just past the center of the apparatus front bumper using even numbers going CW around the passenger side and ending at the exact center of the rear bumper

3. Numbering Scene Light Switches

For instances when there are multiple lights of the same description, number driver side lights beginning at the front of the apparatus using odd numbers. Use even numbers on the passenger side.

4. Numbering Electrical Outlets

Number each electrical outlet circuit. Number each circuit at the circuit breaker or fuse panel. This can be accomplished by directly labeling the fuse or breaker, or by providing a diagram.

Use the Electrical Outlet symbol to label each outlet or cord reel with the number of its corresponding circuit, the circuit voltage, and the circuit amperage. Each circuit may have more than one outlet, so there may be several outlets with identical labels.



5. Symbols with Multiple uses

One of the main goals of this document is to keep the symbols simple and to minimize the number symbols. Keeping with this philosophy, many symbols can be employed to indicate multiple functions. Example: When the water discharge symbol is located on or next to the control it will be apparent that the label is identifying the water discharge control function. When the same symbol is placed next to the discharge outlet it is apparent that the label is identifying the discharge outlet. When the same symbol is located below the pressure gauge it is apparent that the symbol is describing the function of the gauge. For this reason separate symbols for control, outlet, and pressure are not needed.

6. Monitors

If there are multiple monitors on the same apparatus they should be numbered. Number monitors consecutively beginning at the front of the apparatus and moving to the back, then up the aerial device.

7. Aerial Symbols

Where there are multiple devices on the same apparatus, and one of them is associated with the aerial, it is permissible to use the aerial symbol in place of the numbering system.

8. Aerial Monitor Numbering

Number the monitors on an aerial by starting at the center tip of the ladder or in the center of the basket facing along the device. Number monitors to the left with even numbers and to the right as odd numbers and then increasing the number going down the device toward the base.

9. Manual Override Function

Label manual override valves on aerial device functions with the switch interlock override symbol above each of the specific control function symbols.



8 – Base Symbols

Symbol Number	Graphical Symbol	Symbol Description or Application	Reference Number	Reference Standard
8.01		Water	0536	ISO 7000
8.02		Foam Concentrate	3.3.2	CEN 5989:2010
8.03		Foam Solution	3.3.3	CEN 5989:2010
8.04		Powder	3.3.4	CEN 5989:2010
8.05		Compressed Air Foam (CAF) Wet	None	—
8.06		Compressed Air Foam (CAF) Dry	None	—





Graphical Symbols for Automotive Fire Apparatus

Symbol Number	Graphical Symbol	Symbol Description or Application	Reference Number	Reference Standard
8.07		Halotron	None	—
8.08		Location Left Front – Cab or Apparatus	None	—
8.09		Location Right Front – Cab or Apparatus	None	—
8.10		Location Left Rear – Cab or Apparatus	None	—
8.11		Location Right Rear – Cab or Apparatus	None	—



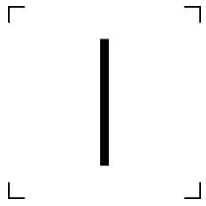
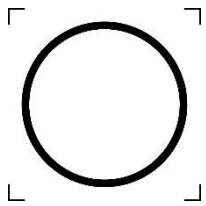
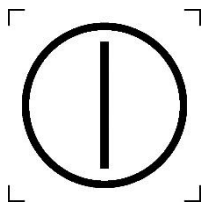
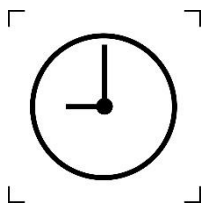

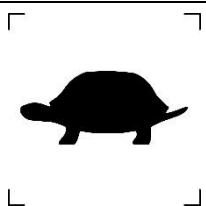

9 – General



Symbol Number	Graphical Symbol	Symbol Description or Application	Reference Number	Reference Standard
9.01		On / Start Use independently or in conjunction with other symbols. Do not use as a graphical element in developing combined symbols per Clause 4.5	5007	IEC 60417
9.02		Off / Stop Use independently or in conjunction with other symbols. Do not use as a graphical element in developing combined symbols per Clause 4.5	5008	IEC 60417
9.03		On and Off Use independently or in conjunction with other symbols. Do not use as a graphical element in developing combined symbols per Clause 4.5	5010	IEC 60417
9.04		Clock / Time Switch / Timer	5184	IEC 60417
9.05		Fast This symbol is published without a registration number in the ISO standards indicated.	9.15	SAE J1362
9.06		Slow This symbol is published without a registration number in the ISO standards indicated.	9.26	SAE J1362



Graphical Symbols for Automotive Fire Apparatus

Symbol Number	Graphical Symbol	Symbol Description or Application	Reference Number	Reference Standard
9.07		Continuously Variable — Linear	5004	IEC 60417
9.08		Continuously Variable — Rotational	1364	ISO 7000
9.09		Unlock - or - Switch Interlock Use to label a switch or control that must be held in the engaged position to allow another switch or control to function (“dead-man” feature)	9.36	SAE J1362
9.10		Bell - or - Alarm Use as an “urgent alert” indicator to call attention to another (already existing) symbol.	2301	ISO 7000
9.11		Manual Operation / Manual Start Use as a symbol element in a combined symbol or in conjunction with a function symbol to indicate manual operating mode.	0096	ISO 7000
9.12	AUTO	Automatic Operation / Automatic Start Use as a symbol element in a combined symbol or in conjunction with a function symbol to indicate automatic operating mode.	9.49	SAE J1362

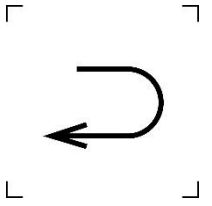
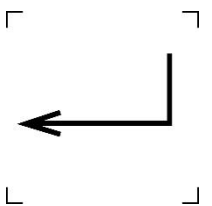
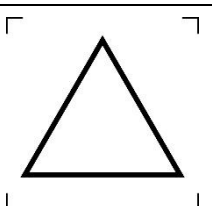
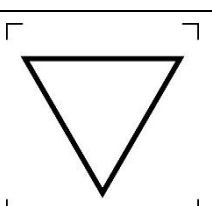

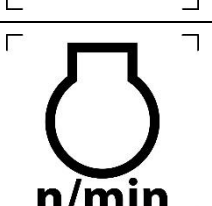
Symbol Number	Graphical Symbol	Symbol Description or Application	Reference Number	Reference Standard
9.13		Back	None	—
9.14		Select	None	—
9.15		Up	None	—
9.16		Down	None	—
9.17		Warning	None	—
9.18		Engine — Rotational Speed	1389	ISO 7000

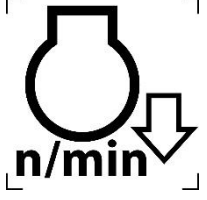
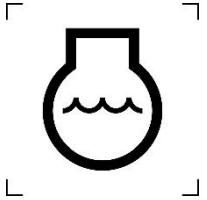
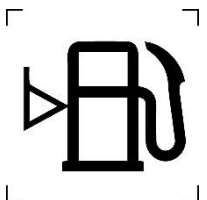
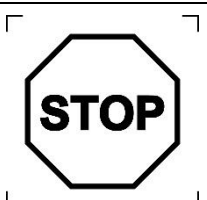
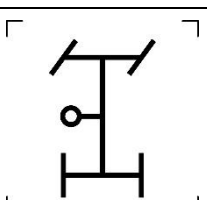
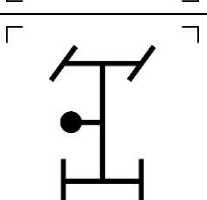

Graphical Symbols for Automotive Fire Apparatus

Symbol Number	Graphical Symbol	Symbol Description or Application	Reference Number	Reference Standard
9.19		Engine — Rotational Speed — Instantaneous Decrease	2308	ISO 7000
9.20		Engine Coolant	1377	ISO 7000
9.21		Fuel — Level	1551	ISO 7000
9.22		Emergency Stop To be shown with white border, red background, and white letters.	10.31	SAE J1362
9.23		Power Take-Off (PTO)	3.1.30	CEN 5989:2010
9.24		Power Take-Off Engage	3.1.31	CEN 5989:2010



Symbol Number	Graphical Symbol	Symbol Description or Application	Reference Number	Reference Standard
9.25		Road Mode Mid-ship pump disengaged and vehicle is ready to drive.	None	—
9.26		Engine Operating Hours	None	—
9.27		Standby	None	—
9.28		Breathing Air (SCBA) Indicate max pressure for breathing air outlets. Symbol without the pressure designations can be used to indicate SCBA storage locations, brackets, etc...	None	—
9.29		Siren, Mechanical	None	—
9.30		Horn	0244	ISO 7000

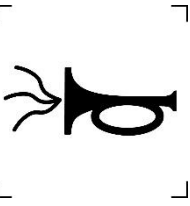
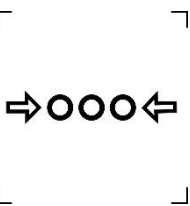
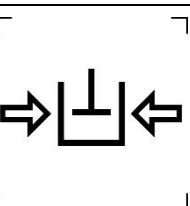
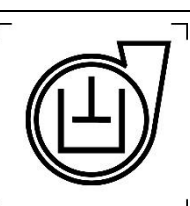
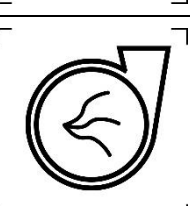
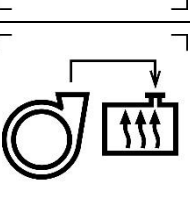

Symbol Number	Graphical Symbol	Symbol Description or Application	Reference Number	Reference Standard
9.31		Air Horn	None	—
9.32		Foam Pressure Foam pressure can also be indicated by placing the basic foam symbol on or underneath the foam pressure gauge.	None	—
9.33		Hydraulic Pressure Hydraulic pressure can also be indicated by placing the basic hydraulic symbol on or underneath the hydraulic pressure gauge.	None	—
9.34		Hydraulic Pump	None	—
9.35		Air Compressor	None	—
9.36		Radiator Re-Fill Use this symbol for the method of refilling the radiator with water from the fire suppression pump in the event that the cooling system springs a leak.	None	—





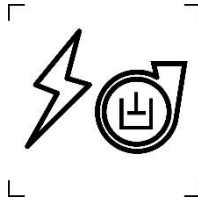
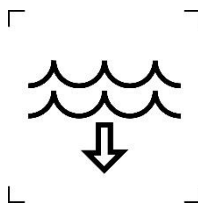
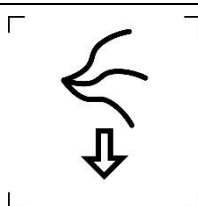
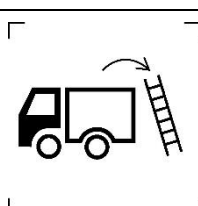
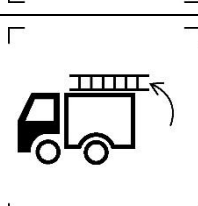
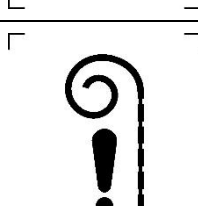

Graphical Symbols for Automotive Fire Apparatus

Symbol Number	Graphical Symbol	Symbol Description or Application	Reference Number	Reference Standard
9.37		Emergency Power Unit Use this symbol for the electric-over-hydraulic pump used to provide emergency hydraulic power in the event of a main apparatus engine or hydraulic pump failure.	None	—
9.38		Water Flush Use this symbol for control valves or fittings that allow a system to be flushed with water.	None	—
9.39		Air Purge or Drain Use this symbol for control valves or fittings that allow a system to be purged with air, or a valve that allows a compressed air device or system to be drained.	None	—
9.40		Ladder Rack Down Use this symbol for control of any powered ladder rack or gantry.	None	—
9.41		Ladder Rack Up Use this symbol for control of any powered ladder rack or gantry.	None	—
9.42		Compartment Door Alert Use this symbol to indicate that a compartment door is not secured.	None	—



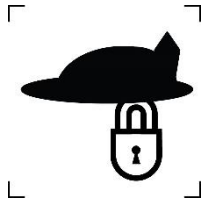
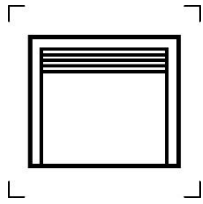

Graphical Symbols for Automotive Fire Apparatus



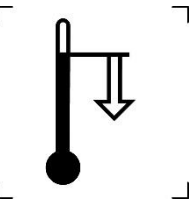

Symbol Number	Graphical Symbol	Symbol Description or Application	Reference Number	Reference Standard
9.43		Pumper Apparatus	None	—
9.44		Aerial Ladder Apparatus	None	—
9.45		Suspension, Front	None	—
9.46		Suspension, Rear	None	—
9.47		Helmet Restraint	None	—
9.48		Compartment Door	None	—

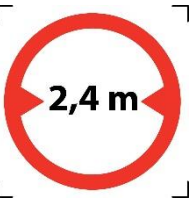
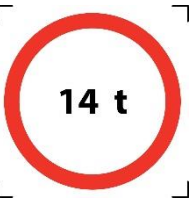
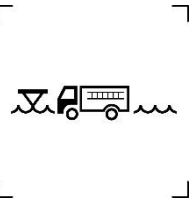

Graphical Symbols for Automotive Fire Apparatus

Symbol Number	Graphical Symbol	Symbol Description or Application	Reference Number	Reference Standard
9.49		Fire Equipment Restraint	None	—
9.50		Auxiliary Cooler	0036 3.3.5	ISO 7000 CEN 15989
9.51		Height of vehicle, hint for driver Fit the sign in the view of driver; diameter of sign approximately 50 mm. Value in feet (ft) and inches (in), or meters(m).	3.3.6	CEN 15989
9.52		Width of vehicle, hint for driver Fit the sign in the view of driver; diameter of sign approximately 50 mm. Value in feet (ft) and inches (in), or meters(m).	3.3.7	CEN 15989
9.53		GVWR of vehicle, hint for driver Fit the sign in the view of driver; diameter of sign approximately 50 mm. Value in tons (t) or metric tons (t)	3.3.8	CEN 15989
9.54		Fording depth, water crossing ability Fit the sign outside in the appropriate height at driver side of the cabin; width of the symbol at least 50 mm	3.3.9	CEN 15989

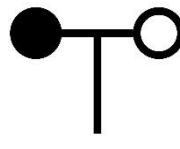

Symbol Number	Graphical Symbol	Symbol Description or Application	Reference Number	Reference Standard
9.55		Fording depth, water crossing ability, hint for driver Fit the sign in the view of driver; diameter of sign approximately 50 mm	3.3.10	CEN 15989
9.56		Video Camera	3.3.20	CEN 15989
9.57		Rear View Video Camera	3.3.21	CEN 15989
9.58		Wind Speed	1698 3.10.27	ISO 7000 CEN 15989
9.59		Compartment Door Open	3.3.15	CEN 15989
9.60		Apparatus Front View	None	—



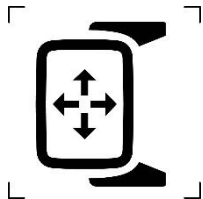
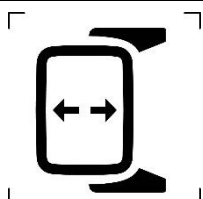
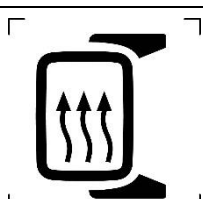
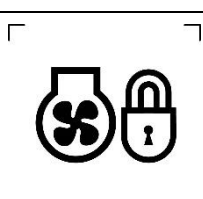
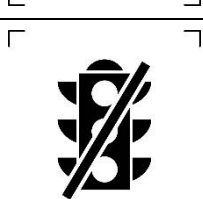

Graphical Symbols for Automotive Fire Apparatus

Symbol Number	Graphical Symbol	Symbol Description or Application	Reference Number	Reference Standard
9.61		Aerial Apparatus Front View	None	—
9.62		Exterior Rear View Mirror – 4-Way Adjustment	2469	ISO 7000
9.63		Exterior Rear View Mirror – 2-Way Adjustment	None	—
9.64		Exterior Rear View Mirror – Heat	2470	ISO 7000
9.65		Engine Cooling Fan Clutch Lock	None	—
9.66		Traffic Signal Preemption OFF	None	—

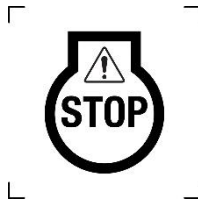
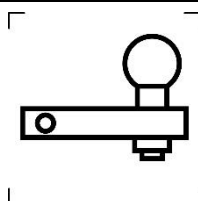
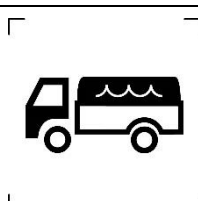
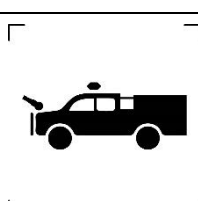
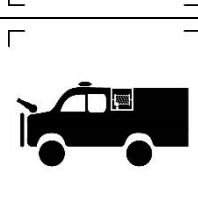

Graphical Symbols for Automotive Fire Apparatus

Symbol Number	Graphical Symbol	Symbol Description or Application	Reference Number	Reference Standard
9.67		Engine Emergency Shut-Down	None	—
9.68		Ball Hitch or Ball Hitch Receiver	None	—
9.69		Tanker or Tender	None	—
9.70		Brush Truck or Mini-Pumper	None	—
9.71		Wildland Apparatus	None	—
9.72		Digital Alert Warning System	None	—



Symbol Number	Graphical Symbol	Symbol Description or Application	Reference Number	Reference Standard
9.73		Siren Brake	None	—
9.74		Automatic Tire Chains	None	—
9.75		Siren Operated by Steering Wheel Center Switch	None	—
9.76		Air Horn Operated by Steering Wheel Center Switch	None	—
9.77		Generator PTO Engage	None	—
9.78		Air Compressor PTO Engage	None	—





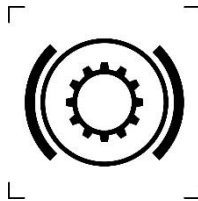
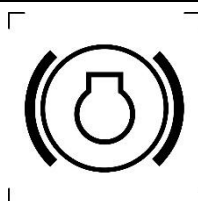
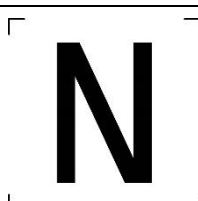
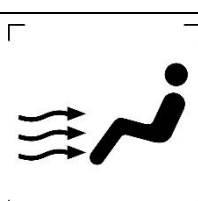
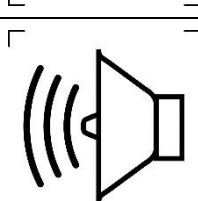
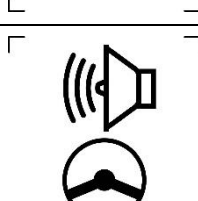

Graphical Symbols for Automotive Fire Apparatus

Symbol Number	Graphical Symbol	Symbol Description or Application	Reference Number	Reference Standard
9.79		Transmission Retarder or Brake	None	—
9.80		Engine Compression or Exhaust Brake	None	—
9.81		Neutral	None	—
9.82		Cab Heat	None	—
9.83		Electronic Siren	None	—
9.84		Electronic Siren Activated through Steering Wheel Horn Button	None	—

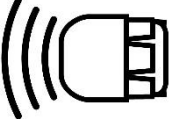

Graphical Symbols for Automotive Fire Apparatus

Symbol Number	Graphical Symbol	Symbol Description or Application	Reference Number	Reference Standard
9.85		Front Axle Brake Lock	None	—
9.86		Extrication Tools	None	—
9.87		Low Frequency Electronic Siren (Rumbler)	None	—
9.88		AM/FM Radio, Stereo, ect...	None	—

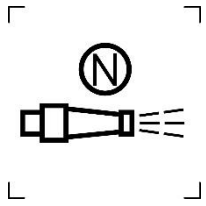
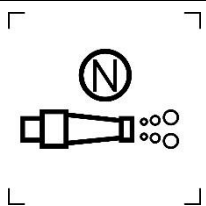
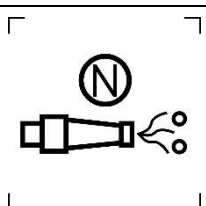
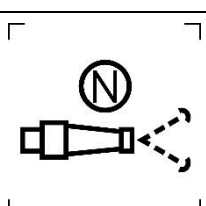
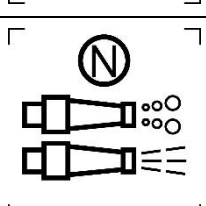
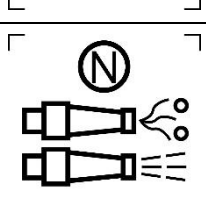

10 – Discharges and Intakes

Symbol Number	Graphical Symbol	Symbol Description or Application	Reference Number	Reference Standard
10.01		Water Discharge Replace “N” with a number designation so that the corresponding control, gauge, and function or device all match.	None	—
10.02		Foam Discharge Replace “N” with a number designation so that the corresponding control, gauge, and function or device all match.	None	—
10.03		CAFS Discharge Replace “N” with a number designation so that the corresponding control, gauge, and function or device all match.	None	—
10.04		Powder Discharge Replace “N” with a number designation so that the corresponding control, gauge, and function or device all match.	None	—
10.05		Foam or Water Discharge Replace “N” with a number designation so that the corresponding control, gauge, and function or device all match.	None	—
10.06		CAFS or Water Discharge Replace “N” with a number designation so that the corresponding control, gauge, and function or device all match.	None	—

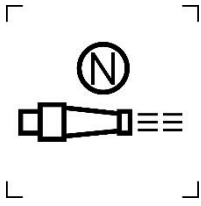
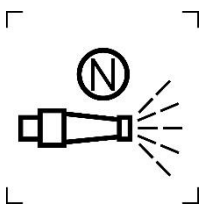
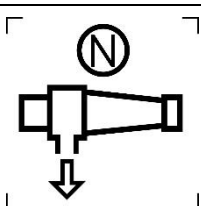
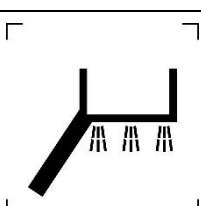
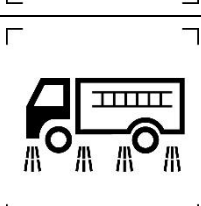
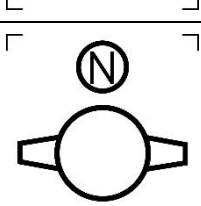

Graphical Symbols for Automotive Fire Apparatus

Symbol Number	Graphical Symbol	Symbol Description or Application	Reference Number	Reference Standard
10.07		Stream	None	—
10.08		Fog	None	—
10.09		Discharge Drain or Bleeder Replace "N" with a number designation so that the corresponding control, gauge, and function or device all match.	None	—
10.10		Aerial Platform Water Curtain	None	—
10.11		Pavement Cooler Discharge	None	—
10.12		Intake Replace "N" with a number designation so that the corresponding control, gauge, and function or device all match.	None	—

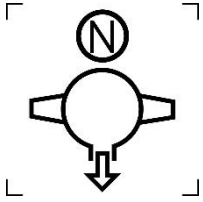
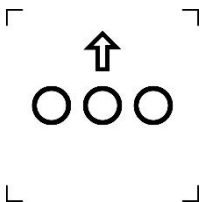
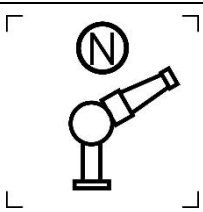
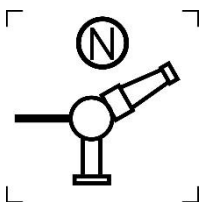
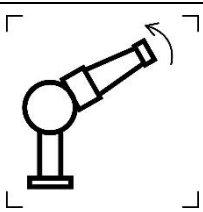
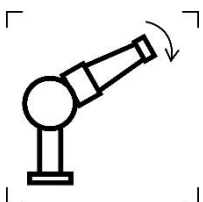

Graphical Symbols for Automotive Fire Apparatus

Symbol Number	Graphical Symbol	Symbol Description or Application	Reference Number	Reference Standard
10.13		Intake Drain or Bleeder Replace "N" with a number designation so that the corresponding control, gauge, and function or device all match.	None	—
10.14		Foam Intake	None	—
10.15		Remote Monitor Replace "N" with a number designation so that the corresponding control, gauge, and function or device all match.	None	—
10.16		Manual Monitor Replace "N" with a number designation so that the corresponding control, gauge, and function or device all match.	None	—
10.17		Monitor Elevate	None	—
10.18		Monitor Depress	None	—

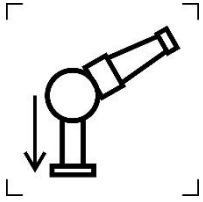
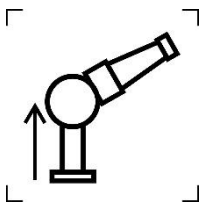
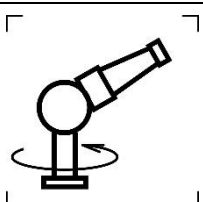
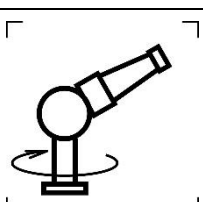
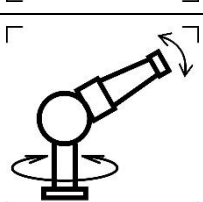
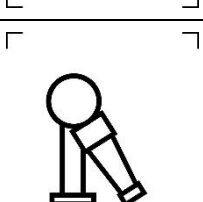

Symbol Number	Graphical Symbol	Symbol Description or Application	Reference Number	Reference Standard
10.19		Monitor Lower	None	—
10.20		Monitor Raise	None	—
10.21		Monitor Rotate CCW	None	—
10.22		Monitor Rotate CW	None	—
10.23		Monitor Oscillate	None	—
10.24		Monitor Stow	None	—

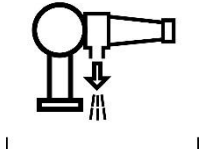
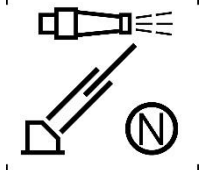
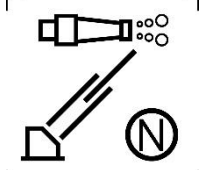
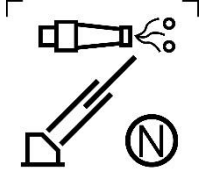
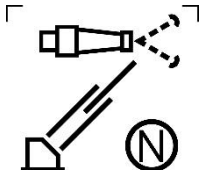
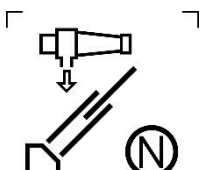

Graphical Symbols for Automotive Fire Apparatus

Symbol Number	Graphical Symbol	Symbol Description or Application	Reference Number	Reference Standard
10.25		Monitor Drain or Bleed	None	—
10.26		Aerial Water Discharge	None	—
10.27		Aerial Foam Discharge	None	—
10.28		Aerial CAF Discharge	None	—
10.29		Aerial Powder Discharge	None	—
10.30		Aerial Discharge Drain	None	—

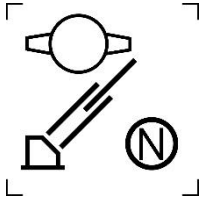
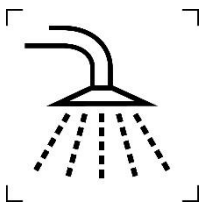
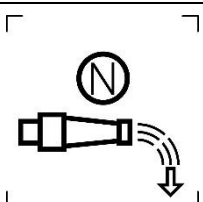
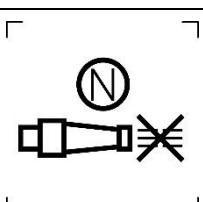
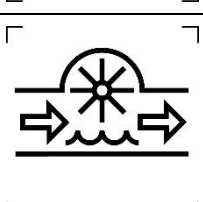
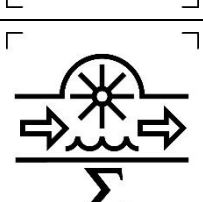

Symbol Number	Graphical Symbol	Symbol Description or Application	Reference Number	Reference Standard
10.31		Aerial Intake	None	—
10.32		Shower Discharge	None	—
10.33		Nozzle Flush	None	—
10.34		Nozzle Off	None	—
10.35		Water Flow Rate	None	—
10.36		Water Flow Total	None	—

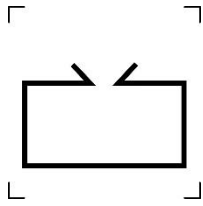
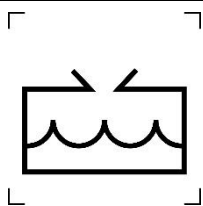
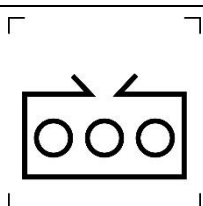
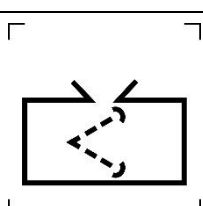
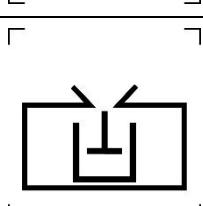
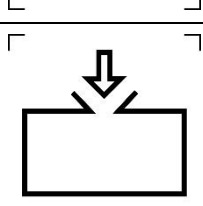

11 - Tanks

Symbol Number	Graphical Symbol	Symbol Description or Application	Reference Number	Reference Standard
11.01		Tank	None	—
11.02		Water Tank	3.5.1	CEN 15989
11.03		Foam Tank	3.5.2	CEN 15989
11.04		Powder Tank	None	—
11.05		Hydraulic Tank	None	—
11.06		Tank Fill	3.5.3 0028	CEN 15989 ISO 7000

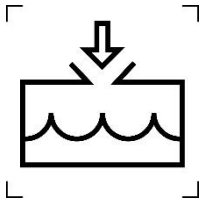
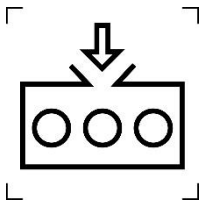
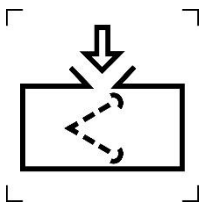
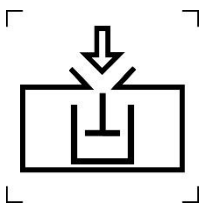
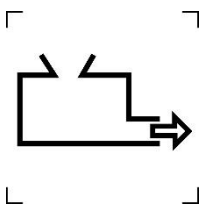
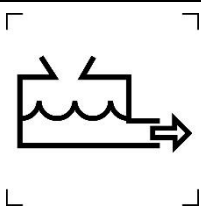

Symbol Number	Graphical Symbol	Symbol Description or Application	Reference Number	Reference Standard
11.07		Water Tank Fill Use this symbol for both top and direct tank fill locations.	None	—
11.08		Foam Tank Fill	None	—
11.09		Powder Tank Fill	None	—
11.10		Hydraulic Tank Fill	None	—
11.11		Tank Outlet	3.5.7	CEN 15989
11.12		Water Tank Outlet	None	—



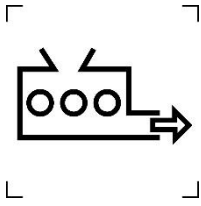
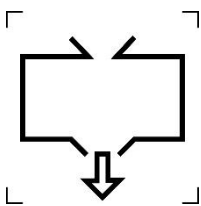
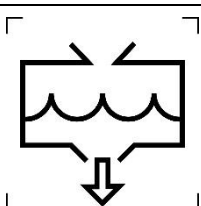
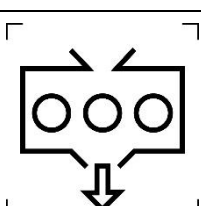
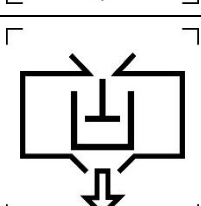
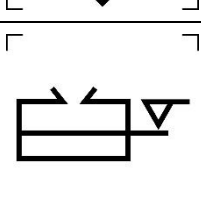

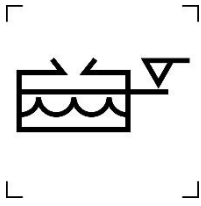
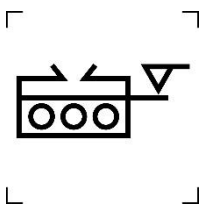
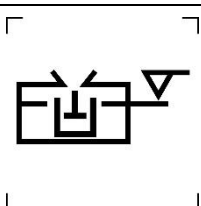
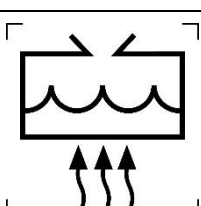
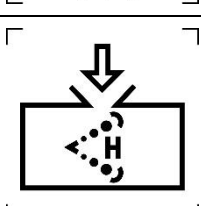
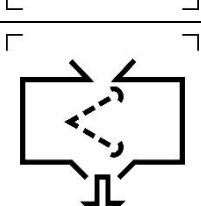

Symbol Number	Graphical Symbol	Symbol Description or Application	Reference Number	Reference Standard
11.13		Foam Tank Outlet	None	—
11.14		Tank Drain	3.5.6 0029	CEN 15989 ISO 7000
11.15		Water Tank Drain	None	—
11.16		Foam Tank Drain	None	—
11.17		Hydraulic Tank Drain	None	—
11.18		Tank Level	3.5.9	CEN 15989



Symbol Number	Graphical Symbol	Symbol Description or Application	Reference Number	Reference Standard
11.19		Water Tank Level	None	—
11.20		Foam Tank Level	None	—
11.21		Hydraulic Tank Level	None	—
11.22		Water Tank Heater	None	—
11.23		Halotron Tank Fill	None	—
11.24		Powder Tank Drain	None	—

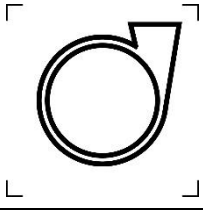

12 - Fire Suppression Pump Functions and Features

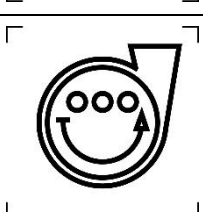
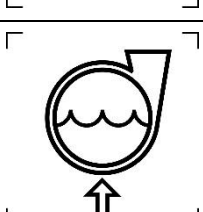
Symbol Number	Graphical Symbol	Symbol Description or Application	Reference Number	Reference Standard
12.01		Pump	3.4.1	CEN 15989
12.02		Pump Engage	None	—
12.03		Pump Engage Manually	None	—
12.04		Water Pump Engage	None	—
12.05		Foam Pump Engage	None	—
12.06		Pump Intake Use this symbol to label the master pump intake pressure gauge and to label the pump intake valve if there is only one intake valve on the apparatus.	None	—

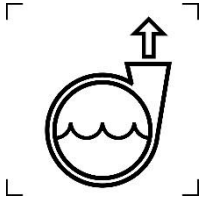
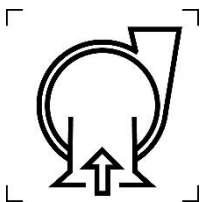
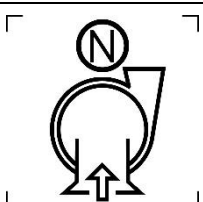
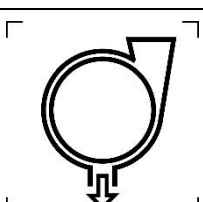
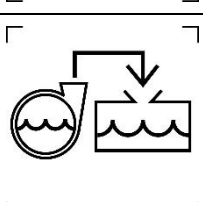
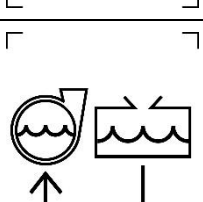

Symbol Number	Graphical Symbol	Symbol Description or Application	Reference Number	Reference Standard
12.07		Pump Discharge Use this symbol to label the master pump discharge pressure gauge and to label the pump discharge valve if there is only one discharge valve on the apparatus.	None	—
12.08		Pump Priming Use this symbol when there is only one pump priming device on the apparatus.	3.4.2	CEN 15989
12.09		Pump Priming Use this symbol when there are more than one priming pumps on the apparatus. Replace "N" with a number to match the pump with its control	None	—
12.10		Pump Drain	3.4.5	CEN 15989
12.11		Pump-to-Tank Valve	None	—
12.12		Tank-to-Pump Valve	None	—

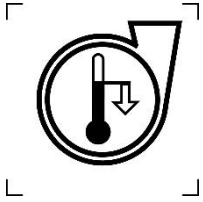
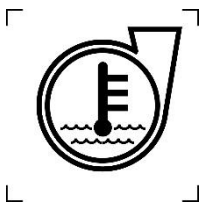
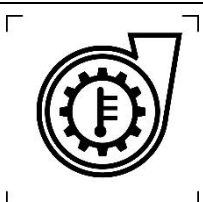
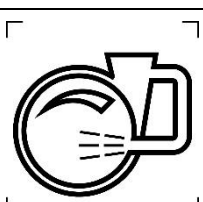
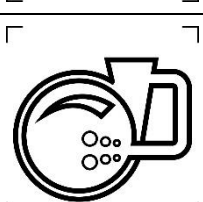
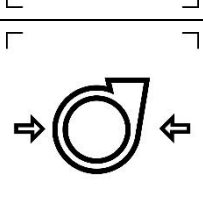

Symbol Number	Graphical Symbol	Symbol Description or Application	Reference Number	Reference Standard
12.13		Pump Cooling Recirculation Valve	None	—
12.14		Pump Water Temperature Use this symbol illuminated in red, or in conjunction with a red lamp, to indicate that the pump water temperature is at a critical level. Use without color to label a pump water temperature gauge.	None	—
12.15		Pump Transmission Temperature Use this symbol illuminated in red, or in conjunction with a red lamp, to indicate that the pump transmission temperature is at a critical level. Use without color to label a pump transmission temperature gauge.	None	—
12.16		Water Pump Discharge Relief	None	—
12.17		Foam Pump Discharge Relief	None	—
12.18		Pump, Low Pressure Use this symbol to label the low pressure control position on a pump which has multiple pressure settings. This would be the single-stage setting of a two-stage pump.	None	—





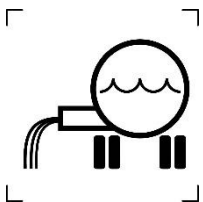
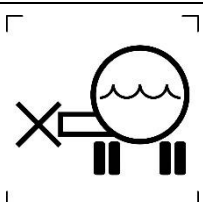
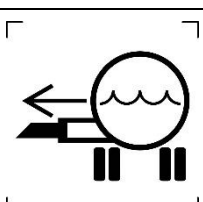
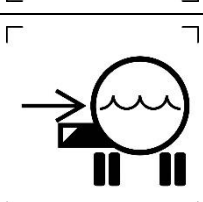
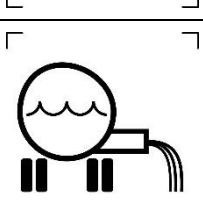

Symbol Number	Graphical Symbol	Symbol Description or Application	Reference Number	Reference Standard
12.19		Pump, High Pressure Use this symbol to label the high pressure control position on a pump which has multiple pressure settings. This would be the two-stage setting of a two-stage pump.	None	—
12.20		Pump, Ultra High Pressure Use this symbol to label the highest pressure control position on a pump which has more than two pressure settings.	None	—
12.21		Pump Heater	None	—
12.22		Pump Compartment Heater	None	—
12.23		Pump Hours Use this symbol to label the meter that keeps track of the running time for the fire suppression pump.	None	—
12.24		Pump Pressure Governor	None	—



Symbol Number	Graphical Symbol	Symbol Description or Application	Reference Number	Reference Standard
12.25		OK to Pump	None	—
12.26		Dump Chute Left OPEN	None	—
12.27		Dump Chute Left CLOSE	None	—
12.28		Dump Chute Left EXTEND	None	—
12.29		Dump Chute Left RETRACT	None	—
12.30		Dump Chute Right OPEN	None	—

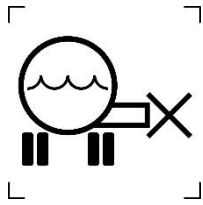
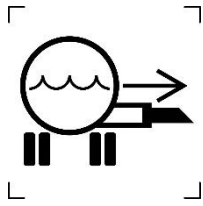
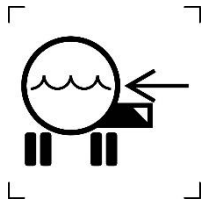

Graphical Symbols for Automotive Fire Apparatus

Symbol Number	Graphical Symbol	Symbol Description or Application	Reference Number	Reference Standard
12.31		Dump Chute Right CLOSE	None	—
12.32		Dump Chute Right EXTEND	None	—
12.33		Dump Chute Right RETRACT	None	—
12.34		Dump Chute Rear OPEN	None	—
12.35		Dump Chute Rear CLOSE	None	—
12.36		Dump Chute Rear EXTEND	None	—



Graphical Symbols for Automotive Fire Apparatus

Symbol Number	Graphical Symbol	Symbol Description or Application	Reference Number	Reference Standard
12.37		Dump Chute Rear RETRACT	None	—

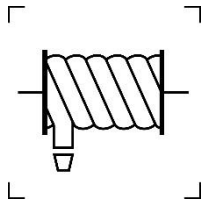
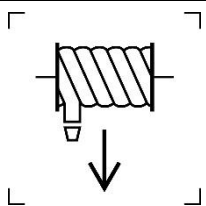
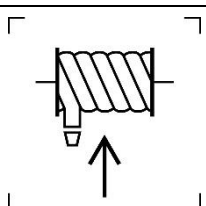
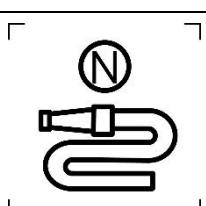
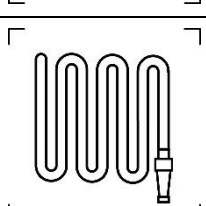
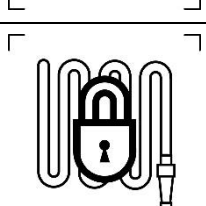

13 - Hose

Symbol Number	Graphical Symbol	Symbol Description or Application	Reference Number	Reference Standard
13.01		Hose Reel	3.8.13	CEN 15989
13.02		Hose Reel Wind Out	3.8.15	CEN 15989
13.03		Hose Reel Wind In	3.8.14	CEN 15989
13.04		Pre-Connect Hose Replace "N" with a number designation so that the corresponding control, gauge, and function or device all match.	None	—
13.05		Hose	None	—
13.06		Hose Restraint	None	—



Graphical Symbols for Automotive Fire Apparatus

Symbol Number	Graphical Symbol	Symbol Description or Application	Reference Number	Reference Standard
13.07		Hose Bed Cover OPEN	None	—
13.08		Hose Bed Cover Close	None	—



14 – Aerial Device

Symbol Number	Graphical Symbol	Symbol Description or Application	Reference Number	Reference Standard
14.01		Aerial Extend	None	—
14.02		Aerial Retract	None	—
14.03		Aerial Elevate	None	—
14.04		Aerial Depress	None	—
14.05		Aerial Rotate CCW	None	—
14.06		Aerial Rotate CW	None	—





Symbol Number	Graphical Symbol	Symbol Description or Application	Reference Number	Reference Standard
14.07		Aerial Articulate Extend	None	—
14.08		Aerial Articulate Retract	None	—
14.09		Aerial Articulate Elevate	None	—
14.10		Aerial Articulate Depress	None	—
14.11		Aerial Boom Raise	None	—
14.12		Aerial Boom Lower	None	—

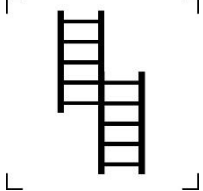
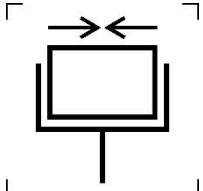
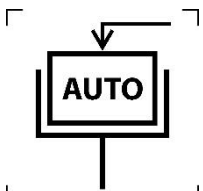
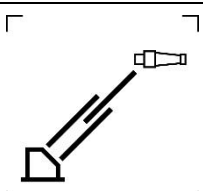
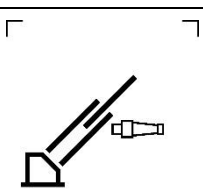
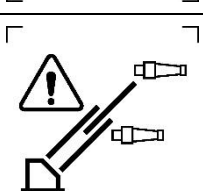



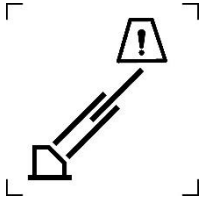

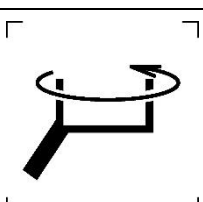
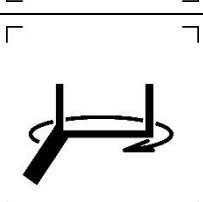
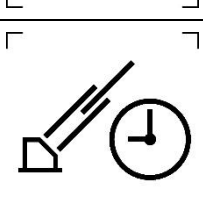
Symbol Number	Graphical Symbol	Symbol Description or Application	Reference Number	Reference Standard
14.13		Ladder Rungs Aligned	None	—
14.14		Aligned With Cradle	None	—
14.15		Automatic Aerial Stowing	None	—
14.16		Aerial Monitor Water Tower Mode	None	—
14.17		Aerial Monitor Rescue Mode	None	—
14.18		Movable Monitor Not Secure	None	—

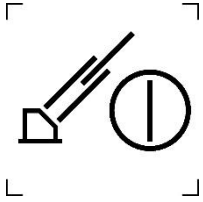

Symbol Number	Graphical Symbol	Symbol Description or Application	Reference Number	Reference Standard
14.19		Aerial Overload	None	—
14.20		Aerial Platform Overload	None	—
14.21		Aerial Platform Leveling	None	—
14.22		Aerial Platform Rotate CCW	None	—
14.23		Aerial Platform Rotate CW	None	—
14.24		Aerial Hours	None	—

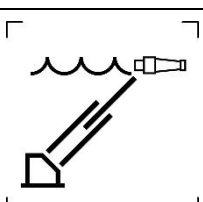
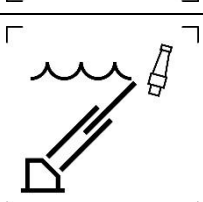

Symbol Number	Graphical Symbol	Symbol Description or Application	Reference Number	Reference Standard
14.25		Aerial Power	None	—
14.26		Aerial Device Enable Control that will unlock the aerial device after it has been paused by and interlock or other event.	None	—
14.27		Tip Controls Enable Control that must be engaged to allow the secondary operator to control the aerial from the tip or from the platform.	None	—
14.28		Aerial Waterway Wet Indicates that the waterway is charged or full of water	None	—
14.29		Aerial Monitor Nozzle Angle Up Indicates that the monitor is angled above the angle of the ladder.	None	—
14.30		Aerial Body Collision Alert		



Graphical Symbols for Automotive Fire Apparatus

Symbol Number	Graphical Symbol	Symbol Description or Application	Reference Number	Reference Standard
14.31		Aerial Body Collision - OFF	None	—
14.32		Aerial Device Not Stowed	None	—
14.33		Stabilizer Not Stowed	None	—
14.34		Trailer Jackknife Warning	None	—





15 - Stabilizers

Symbol Number	Graphical Symbol	Symbol Description or Application	Reference Number	Reference Standard
15.01L		Left Stabilizer Up	23-02	SAE J1362
15.01R		Right Stabilizer Up	23-04	SAE J1362
15.02L		Left Stabilizer Down	23-01	SAE J1362
15.02R		Right Stabilizer Down	23-03	SAE J1362
15.03L		Left Beam In	24-03	SAE J1362
15.03R		Right Beam In	24-05	SAE J1362



Symbol Number	Graphical Symbol	Symbol Description or Application	Reference Number	Reference Standard
15.04L		Left Beam Out	24-02	SAE J1362
15.04R		Right Beam Out	24-04	SAE J1362
15.05L		Left Jack Up	24-07	SAE J1362
15.05R		Right Jack Up	24-09	SAE J1362
15.06L		Left Jack Down	24-06	SAE J1362
15.06R		Right Jack Down	24-08	SAE J1362

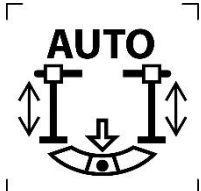
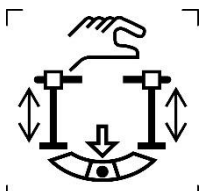

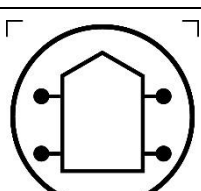
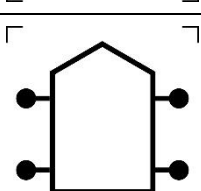
Symbol Number	Graphical Symbol	Symbol Description or Application	Reference Number	Reference Standard
15.07		Stabilizer Off-Level Warning	None	—
15.08		Stabilizers Automatic Leveling	None	—
15.09		Stabilizers Manual Leveling	None	—
15.10		Stabilizers Short-Jacked Warning	None	—
15.11		Stabilizers Set	2967 3.1.13	ISO 7000 CEN 15989
15.12		Stabilizer Locations	1222 3.1.12	ISO 7000 CEN 15989

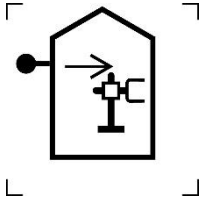
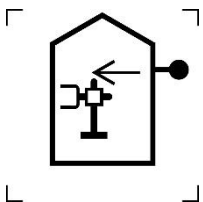
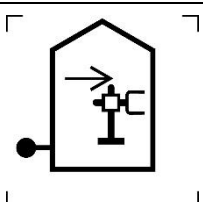
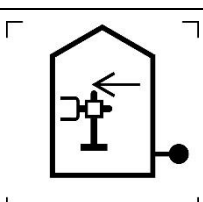
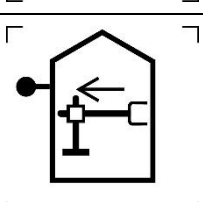
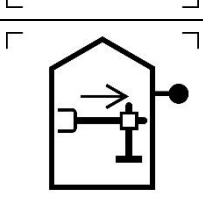

Symbol Number	Graphical Symbol	Symbol Description or Application	Reference Number	Reference Standard
15.13FL		Front Left Beam In	None	—
15.13FR		Front Right Beam In	None	—
15.13RL		Rear Left Beam In	None	—
15.13RR		Rear Right Beam In	None	—
15.14FL		Front Left Beam Out	None	—
15.14FR		Front Right Beam Out	None	—

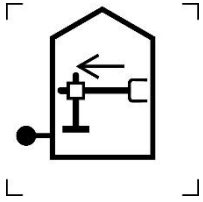
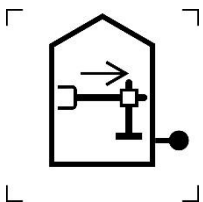
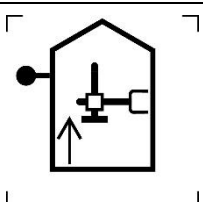
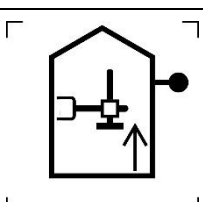
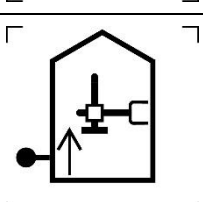
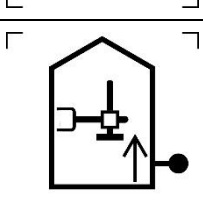

Graphical Symbols for Automotive Fire Apparatus

Symbol Number	Graphical Symbol	Symbol Description or Application	Reference Number	Reference Standard
15.14RL		Rear Left Beam Out	None	—
15.14RR		Rear Right Beam Out	None	—
15.15FL		Front Left Jack Up	None	—
15.15FR		Front Right Jack Up	None	—
15.15RL		Rear Left Jack Up	None	—
15.15RR		Rear Right Jack Up	None	—

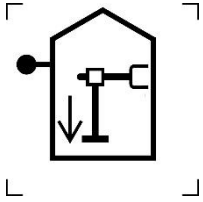
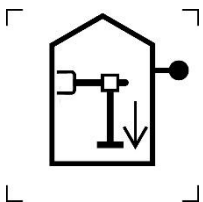
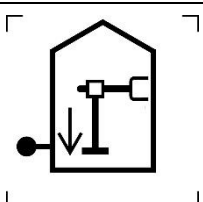
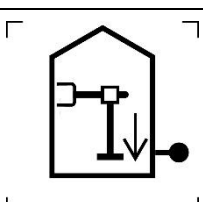
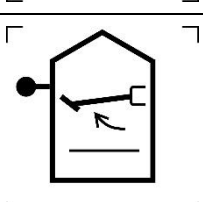
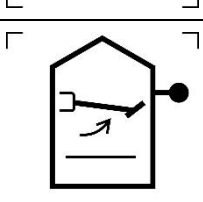

Symbol Number	Graphical Symbol	Symbol Description or Application	Reference Number	Reference Standard
15.16FL		Front Left Jack Down	None	—
15.16FR		Front Right Jack Down	None	—
15.16RL		Rear Left Jack Down	None	—
15.16RR		Rear Right Jack Down	None	—
15.17FL		Front Left Stabilizer Up	None	—
15.17FR		Front Right Stabilizer Up	None	—



Symbol Number	Graphical Symbol	Symbol Description or Application	Reference Number	Reference Standard
15.17RL		Rear Left Stabilizer Up	None	—
15.17RR		Rear Right Stabilizer Up	None	—
15.18FL		Front Left Stabilizer Down	None	—
15.18FR		Front Right Stabilizer Down	None	—
15.18RL		Rear Left Stabilizer Down	None	—
15.18RR		Rear Right Stabilizer Down	None	—





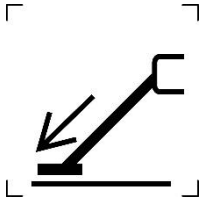
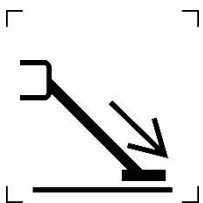
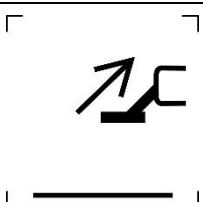
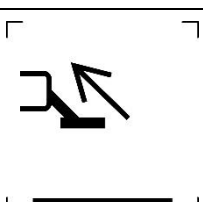

Graphical Symbols for Automotive Fire Apparatus

Symbol Number	Graphical Symbol	Symbol Description or Application	Reference Number	Reference Standard
15.19L		Left Stabilizer Extend, Inclined	2075 3.4.15	ISO 7000 CEN 15989
15.19R		Right Stabilizer Extend, Inclined	None	—
15.20L		Left Stabilizer Retract, Inclined	2076 3.4.16	ISO 7000 CEN 15989
15.20R		Right Stabilizer Retract, Inclined	None	—

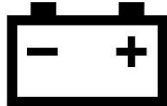
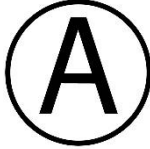

16 - Electrical

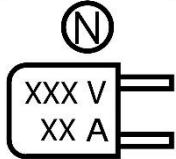
Symbol Number	Graphical Symbol	Symbol Description or Application	Reference Number	Reference Standard
16.01		Battery	0247	ISO 7000
16.02		Ammeter	3.2.5	CEN 15989
16.03		Generator	1153	ISO 7000
16.04		Generator Pre-Heater	None	—
16.05		Voltmeter	3.2.4	CEN 15989
16.06		Electrical Outlet Replace "N" with the number of the circuit that it is powered from. Replace the xxx with the voltage and xx with the amperage of the circuit.	None	—



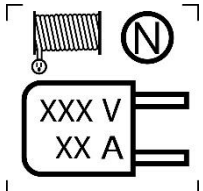
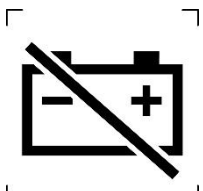
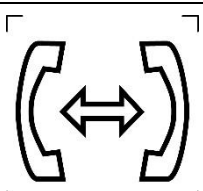

Graphical Symbols for Automotive Fire Apparatus

Symbol Number	Graphical Symbol	Symbol Description or Application	Reference Number	Reference Standard
16.07		Electrical Cord Reel Outlet Replace "N" with the number of the circuit that it is powered from. Replace the xxx with the voltage and xx with the amperage of the circuit.	None	—
16.08		Battery Disconnect; Battery Shut-Off	2063 3.5.5	ISO 7000 CEN 15989
16.09		Intercom	None	—



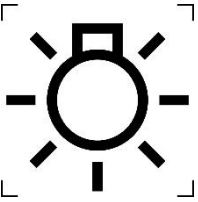
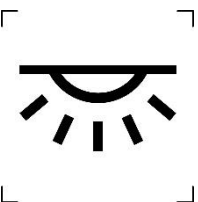

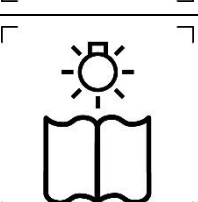
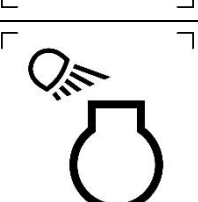

17 - Lighting



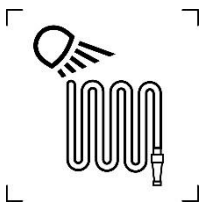

Symbol Number	Graphical Symbol	Symbol Description or Application	Reference Number	Reference Standard
17.01		Panel Light Use this symbol for the pump panel light control, instrument panel light control, or similar lighting that illuminates controls or gauges.	15.16 5012	SAE J1362 IEC 60417
17.02		Dome Light	15.7 1421B	SAE J1362 ISO 7000
17.03		Flood Light	1204	ISO 7000
17.04		Adjustable Work Light	1142	ISO 7000
17.05		Reading Light	3.2.10	CEN 15989
17.06		Engine Compartment Light	None	—



Graphical Symbols for Automotive Fire Apparatus

Symbol Number	Graphical Symbol	Symbol Description or Application	Reference Number	Reference Standard
17.07		Pump Compartment Light	None	—
17.08		Hose Bed Light	None	—
17.09		Front Scene Light	None	—
17.10		Rear Scene Light	None	—
17.11		Left Side Scene Light	None	—
17.12		Right Side Scene Light	None	—

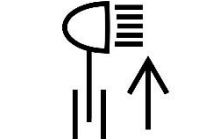
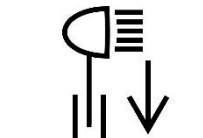

Symbol Number	Graphical Symbol	Symbol Description or Application	Reference Number	Reference Standard
17.13		Perimeter Ground Lights	None	—
17.14		Elevating Light	None	—
17.15		Elevating Light Raise	None	—
17.16		Elevating Light Lower	None	—
17.17		Elevating Light Elevate	None	—
17.18		Elevating Light Depress	None	—



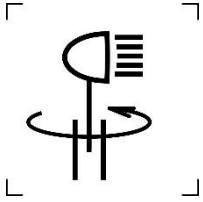
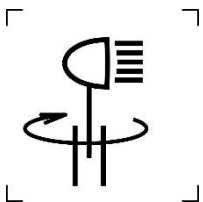
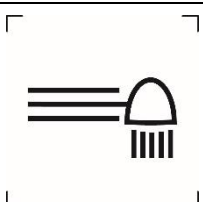
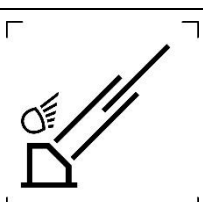
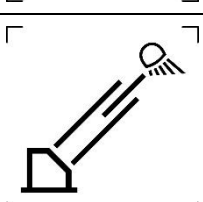
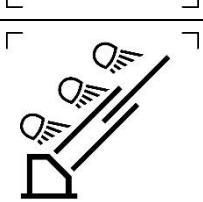

Symbol Number	Graphical Symbol	Symbol Description or Application	Reference Number	Reference Standard
17.19		Elevating Light Rotate CCW	None	—
17.20		Elevating Light Rotate CW	None	—
17.21		Elevating Light Stow Use this symbol regardless of how the light and mast physically fold up.	None	—
17.22		Aerial Base Lights	None	—
17.23		Aerial Tip Lights	None	—
17.24		Aerial Ladder Climbing Lights	None	—



Symbol Number	Graphical Symbol	Symbol Description or Application	Reference Number	Reference Standard
17.25		Day-Night Switch	3.2.9	CEN 15989
17.26		Low level interior illumination To identify the control for the interior compartment lighting used to assist in maintaining the dark adaptation (night vision) of the operator while providing illumination to the interior.	2667	ISO 7000
17.27		Aerial Tip Light – Line Voltage	None	—
17.28		Aerial Tip Light - Low Voltage	None	—
17.29		Blocking Mode - Night	None	—
17.30		Platform Bucket Bottom Lights	None	—

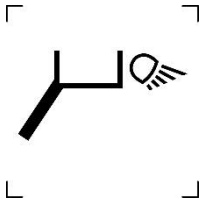

Graphical Symbols for Automotive Fire Apparatus

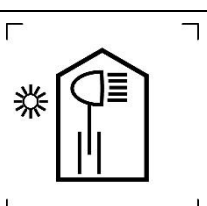
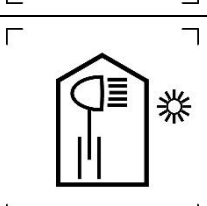
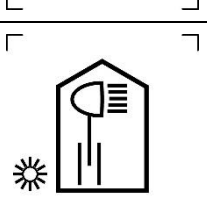
Symbol Number	Graphical Symbol	Symbol Description or Application	Reference Number	Reference Standard
17.31		Platform Bucket Front Lights	None	—
17.32		Platform Bucket Side Lights	None	—
17.33		Emergency Master Lighting (Preferred RED Switch Color)	None	—
17.34		Elevating Light Behind Cab Left Side	None	—
17.35		Elevating Light Behind Cab Right Side	None	—
17.36		Elevating Light Rear Body Left Side	None	—

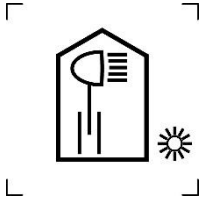
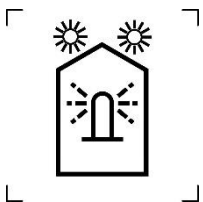
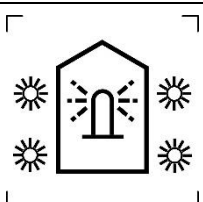
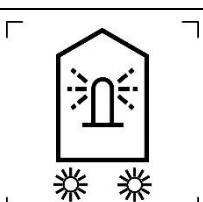
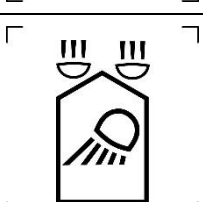
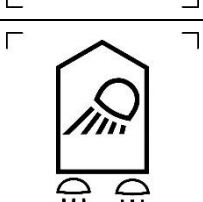

Symbol Number	Graphical Symbol	Symbol Description or Application	Reference Number	Reference Standard
17.37		Elevating Light Rear Body Right Side	None	—
17.38		Warning Lights, Front	None	—
17.39		Warning Lights, Side	None	—
17.40		Warning Lights, Rear	None	—
17.41		Scene Lights, Front	None	—
17.42		Scene Lights, Rear	None	—



Graphical Symbols for Automotive Fire Apparatus

Symbol Number	Graphical Symbol	Symbol Description or Application	Reference Number	Reference Standard
17.43		Alley Light, Left Side	None	—
17.44		Alley Light, Right Side	None	—
17.45		Scene Lights, Left Side	None	—
17.45F		Scene Lights, Left, Front	None	—
17.45R		Scene Lights, Left, Rear	None	—
17.46		Scene Lights, Right Side	None	—



Symbol Number	Graphical Symbol	Symbol Description or Application	Reference Number	Reference Standard
17.46F		Scene Lights, Right, Front	None	—
17.46R		Scene Lights, Right, Rear	None	—
17.47		Headlamp Wig-Wag	None	—
17.48		Warning Light, Mechanical Spinning	None	—
17.49		White Warning Lights OFF	None	—
17.50		Warning Light, Single, Front	None	—



Symbol Number	Graphical Symbol	Symbol Description or Application	Reference Number	Reference Standard
17.51		Compartment Light	None	—
17.52		Light Bar	None	—
17.53		Brow Light Narrow Beam	None	—
17.54		Brow Light Wide Beam	None	—
17.55		Headlights Flashing	None	—
17.56		Docking Lights	None	—

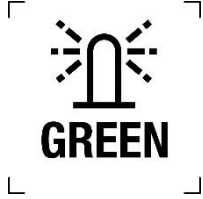

Graphical Symbols for Automotive Fire Apparatus

Symbol Number	Graphical Symbol	Symbol Description or Application	Reference Number	Reference Standard
17.57		Command Light, Green	None	—

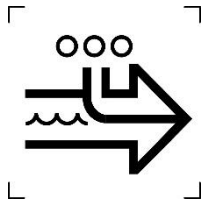
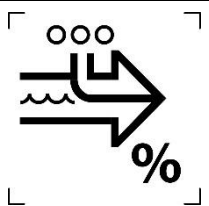
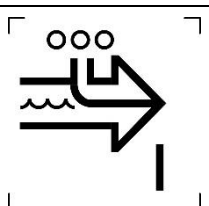
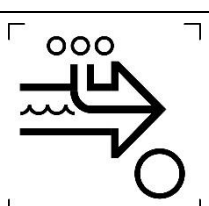
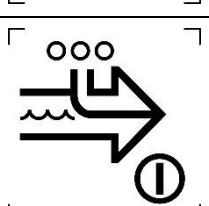
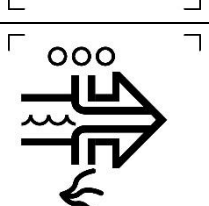

18 - Foam and CAFS

Symbol Number	Graphical Symbol	Symbol Description or Application	Reference Number	Reference Standard
18.01		Foam Concentrate Injection	3.6.8	CEN 15989
18.02		Foam Concentrate Injection Rating by Percent	3.6.9	CEN 15989
18.03		Foam Concentrate Injection, ON	3.6.10	CEN 15989
18.04		Foam Concentrate Injection, OFF	3.6.11	CEN 15989
18.05		Foam Concentrate Injection, ON-OFF	3.6.12	CEN 15989
18.06		Foam Concentrate and Air Injection	3.6.13	CEN 15989



Graphical Symbols for Automotive Fire Apparatus

Symbol Number	Graphical Symbol	Symbol Description or Application	Reference Number	Reference Standard
18.07		Foam Concentrate and Air Injection, ON	3.6.14	CEN 15989
18.08		Foam Concentrate and Air Injection, OFF	3.6.15	CEN 15989
18.09		Foam Concentrate and Air Injection, ON-OFF	3.6.16	CEN 15989



19 – Revisions

Date	Graphical Symbol(s)	Description of Change
10/01/2014	15.11	Replaced "Stabilizers Set" pictorial with image used by ISO 7000 and CEN 15989
10/01/2014	15.01 – 15.06	Replaced stabilizer pictorials with images from ISO 7000 and SAE J1362
10/01/2014	15.12 – 15.18	Added pictorials that depict the function as well as the location of the stabilizer controls using a combination of symbols from ISO 7000 and SAE J1362.
12/23/2017		Updated document format to new FAMA logo and appearance.
12/23/2017	17.26	New symbol for low level interior illumination to stay current with changes to SAE and ISO 7000 and as an alternative to the day-night switch icon.
12/23/2017	9.33, 9.34, 9.37	Revised hydraulic cylinder symbol closer to the proportions found in SAE J1362
12/23/2017	9.43 Thru 9.49	Added base symbols for pumper and aerial apparatus, suspensions, helmet restraint, roll-up door, and equipment restraint.
12/23/2017	12.24	Added symbol for pressure governor
12/23/2017	13.05, 13.06, 17.08	Added symbols for hose and hose restraint. Updated hose bed light symbol to use new hose graphics.
12/23/2017	15.08, 15.09, 15.10	Updated graphics to reflect changes previously made to the stabilizer symbols in conformance with SAE J1362



Graphical Symbols for Automotive Fire Apparatus

12/23/2017	Color Chart	Added standard safety color chart to assist graphic designers in producing consistent art.
12/23/2017	CEN 15989	Added misc. symbols from the 2015 version of CEN 15989: 3.3.6, 3.3.7, 3.3.8, 3.3.9, 3.3.10, 3.3.5, 3.3.20, 3.3.21, 3.4.15, 3.4.16, 3.5.5, 3.5.28, 3.10.27
12/23/2017	FOAM Chapter	Added Chapter 18 Foam and CAFS to contain the foam and CAFS symbols from the 2015 version of CEN 15989
04/27/2018	9.60, 9.61, 10.33, 10.34, 14.26, 14.27, 14.28, 14.29, 17.27, 17.28	Added New Symbols
04/17/2019	9.62 – 9.74 14.30, 14.31 17.29 – 17.49	Added New Symbols
05/02/2019	9.75 - 9.80 12.25 – 12.37 16.09	Added New Symbols
10/10/2019	8.08 - 8.11 9.81 – 9.88 13.07 – 13.08 14.32 – 14.34 17.50 – 17.57	Added New Symbols